

The background of the entire page is a vibrant teal color. It features a complex, organic pattern that combines the texture of water ripples with the shapes of leaves. The water ripples are more prominent on the right side, while the leaves are more visible on the left. The overall effect is a sense of natural, fluid movement.

op
_en
air

CONCEPT

DURSTONE

op
_en
air

CONCEPT

open air _CONCEPT

Convierte el exterior de tu casa en el corazón de tu hogar

Transform the outdoor of your house into the heart of your home

En DURSTONE queremos darte las facilidades necesarias para prolongar hacia el exterior la estética y confort que disfrutas en el interior de tu hogar. Las propiedades del gres porcelánico (resistente a la abrasión, al hielo, al fuego y a los productos químicos; nula absorción de agua, superficie inalterable y antideslizante) así como su variedad gráfica y estética le convierten en la opción perfecta para espacios exteriores. Tanto si tienes una pequeña e íntima terraza como si planeas construir una piscina, nuestras colecciones te garantizan los máximos niveles de calidad, seguridad y estética.

Prepárate para conocer una variedad de productos específicos concebidos para lograr ese espacio de descanso al aire libre con el que sueñas.

In DURSTONE we want to give you the necessary facilities to extend to the outside aesthetics and comfort that you enjoy inside your home. The properties of gres porcelanic (resistant to abrasion, ice, fire and chemicals; zero water absorption, unalterable and non-slip surface) as well as its graphic variety and aesthetics it makes the perfect choice for outdoor spaces. Whether you have a small and intimate terrace or swimming pool, our collections guarantee you the highest levels of quality, safety and aesthetics.

Get ready to meet a variety of specific products designed to achieve that outdoor comfortable outdoor space you dream of.

Series

- Clunia 04.
- Frame 16.
- Jasper 26.
- Tucson 34.

Disfruta

Enjoy



Clunia

Un sutil conglomerado de pequeñas piedras en tonos muy naturales es la clave de esta colección. Elegante y sobria se mimetiza perfectamente en entornos actuales.

A fine mixture of small stones in very natural tones is the key to this collection. Elegant and sober blends perfectly into today's environments.



Porcelánico Antislip - Antislip porcelain tiles

La opción antislip con una superficie Clase 3/R11 te permite prolongar el aspecto del suelo interior a espacios exteriores como porches, terrazas y alrededores de piscina. Perfecta para evitar resbalones.

The anti-slip option with a Class 3 / R11 surface allows to extend the appearance of the interior floor to exterior spaces such as porches, terraces and pool surroundings. Perfect to avoid slipping.



FLOOR Clunia Antracita Natural 100x100 - Clunia Antracita Antislip 100x100x2



FLOOR Clunia Arena Natural 75x75 - Clunia Arena Antislip 75x75
Peldaño Recto Clunia Arena Antislip 33x120



En fachada - Façades

Sus cualidades técnicas y estéticas convierten al porcelánico en una opción ideal para recubrimientos exteriores. Aplacado o con sistemas de fachada ventilada te permitirá dar un aspecto más homogéneo al conjunto de tu hogar. Its technical and esthetic features make porcelain tiles an ideal option for exterior coatings. Cladding or with ventilated façade systems will allow you to give a more homogeneous appearance to your home.

WALL Clunia Arena Natural 30x60
FLOOR Clunia Arena Antislip 60x120 - Clunia Arena Antislip 100x100x2 - Peldaño Recto Clunia Arena Antislip 33x120

Clunia

Gris







Antracita

100x100 • 100x100x2 • 75x75 • 60x60 • 60x120 • 30x60
40"x40" • 40"x40"x0,8" • 30"x30" • 24"x24" • 24"x48" • 12"x24"

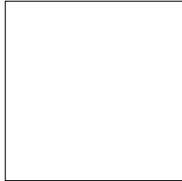



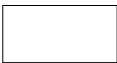

MAX. 20% C3 / R11





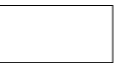

Natural

						
CLUNIA GRIS 100x100 - 40"x40" DUR1650	CLUNIA GRIS 75x75 - 30"x30" DUR1550	CLUNIA GRIS 60x120 - 24"x48" DUR1100	CLUNIA GRIS 60x60 - 24"x24" DUR900	CLUNIA GRIS 30x60 - 12"x24" DUR1400	MOSAICO CLUNIA GRIS 30x30 - 12"x12" PESP500	MOSAICO MURO CLUNIA GRIS 30x30 - 12"x12" PESP800

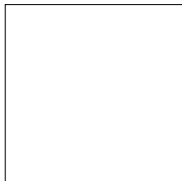
Natural

					
CLUNIA ANTRACITA 100x100 - 40"x40" DUR1650	CLUNIA ANTRACITA 75x75 - 30"x30" DUR1550	CLUNIA ANTRACITA 60x60 - 24"x24" DUR900	CLUNIA ANTRACITA 30x60 - 12"x24" DUR1400	MOSAICO CLUNIA ANTRACITA 30x30 - 12"x12" PESP500	MOSAICO MURO CLUNIA ANTRACITA 30x30 - 12"x12" PESP800

Antislip

						
CLUNIA GRIS 100x100 - 40"x40" DUR1900	CLUNIA GRIS 75x75 - 30"x30" DUR1650	CLUNIA GRIS 60x120 - 24"x48" DUR1100	CLUNIA GRIS 60x60 - 24"x24" DUR1000	CLUNIA GRIS 30x60 - 12"x24" DUR1500	NEW PELD. RECTO EXTRUS. CLUNIA GRIS 33x120 PESP6100	CLUNIA GRIS 100x100x2 - 40"x40"x0,8" DUR3900

Antislipx2

Antislipx2

CLUNIA ANTRACITA 100x100x2 - 40"x40"x0,8" DUR3900

Natural







Arena

100x100 • 100x100x2 • 75x75 • 60x60 • 60x120 • 30x60



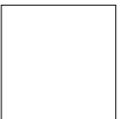



40"x40" • 40"x40"x0,8" • 30"x30" • 24"x24" • 24"x48" • 12"x24"







Natural

						
CLUNIA NATURAL 100x100 - 40"x40" DUR1650	CLUNIA NATURAL 75x75 - 30"x30" DUR1550	CLUNIA NATURAL 60x120 - 24"x48" DUR1100	CLUNIA NATURAL 60x60 - 24"x24" DUR900	CLUNIA NATURAL 30x60 - 12"x24" DUR1400	MOSAICO CLUNIA NATURAL 30x30 - 12"x12" PESP500	MOSAICO MURO CLUNIA NATURAL 30x30 - 12"x12" PESP800



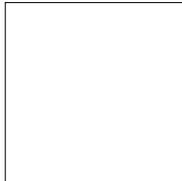

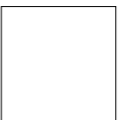
Natural

						
CLUNIA ARENA 100x100 - 40"x40" DUR1650	CLUNIA ARENA 75x75 - 30"x30" DUR1550	CLUNIA ARENA 60x120 - 24"x48" DUR1100	CLUNIA ARENA 60x60 - 24"x24" DUR900	CLUNIA ARENA 30x60 - 12"x24" DUR1400	MOSAICO CLUNIA ARENA 30x30 - 12"x12" PESP500	MOSAICO MURO CLUNIA ARENA 30x30 - 12"x12" PESP800

Antislip

					
CLUNIA NATURAL 100x100 - 40"x40" DUR1900	CLUNIA NATURAL 75x75 - 30"x30" DUR1650	CLUNIA NATURAL 60x120 - 24"x48" DUR1100	CLUNIA NATURAL 60x60 - 24"x24" DUR1000	CLUNIA NATURAL 30x60 - 12"x24" DUR1500	NEW PELD. RECTO EXTRUS. CLUNIA NATURAL 33x120 PESP6100

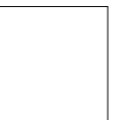
Antislip

					
CLUNIA ARENA 100x100 - 40"x40" DUR1900	CLUNIA ARENA 75x75 - 30"x30" DUR1650	CLUNIA ARENA 60x120 - 24"x48" DUR1100	CLUNIA ARENA 60x60 - 24"x24" DUR1000	CLUNIA ARENA 30x60 - 12"x24" DUR1500	NEW PELD. RECTO EXTRUS. CLUNIA ARENA 33x120 PESP6100

Antislipx2

CLUNIA ARENA 100x100x2 - 40"x40"x0,8" DUR3900



Frame



Su diseño actual y sobrio a la vez que polivalente convierte a esta serie en la opción perfecta para lograr espacios atemporales y de elevado valor estético.

Its current and sober design at the same time as versatile makes this series the perfect option to achieve timeless spaces with high aesthetic value.

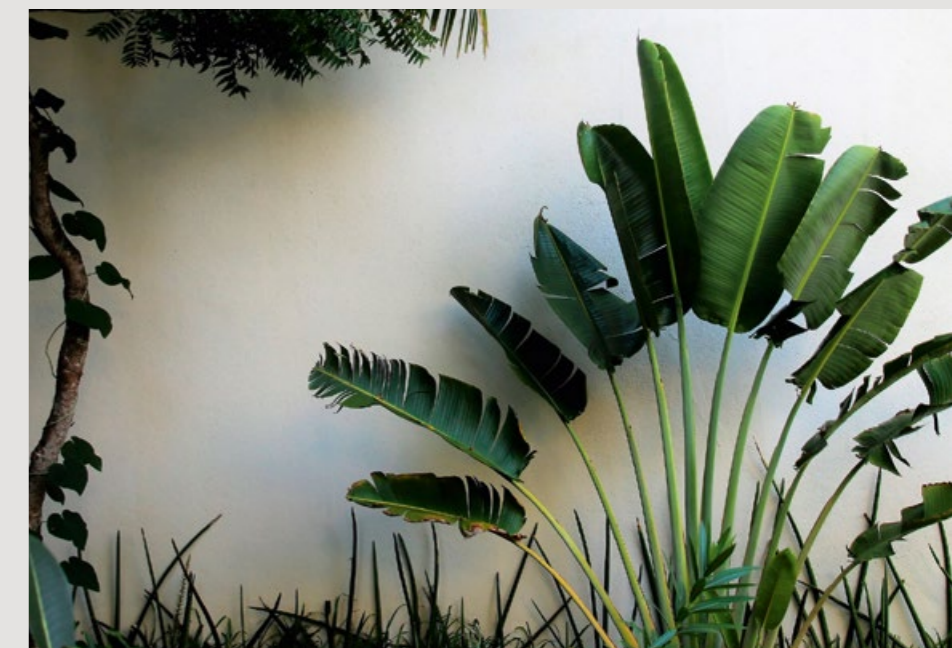

Porcelánico espesorado x2 - Porcelain thickness x2

Las piezas con un espesor de 2 cm y superficie antideslizantes Clase3/R11 pueden colocarse directamente sobre gravilla, césped, hormigón, etc... Juega con ellas y crea senderos a tu gusto.

The pieces with a thickness of 2 cm and a Class3 / R11 non-slip surface can be placed directly on gravel, grass, concrete, etc. Play with them and create trails to your liking.

Frame



Gran variedad - Great variety

La posibilidad que da el porcelánico de elegir entre diferentes acabados, colores y formatos permite disponer de más opciones a la hora de personalizar cualquier proyecto.

Porcelain tiles give you the possibility to choose between different finishes, colors and sizes. All this allows you to have more options when it comes to customizing any project.



FLOOR

Frame Marfil Natural 100x100

Frame Marfil Antislip 100x100

Peldaño Recto Frame Marfil Antislip 33x120

Frame

Gris

Grafito

100x100 • 100x100x2 • 60x60
40"x40" • 40"x40"x0,8" • 24"x24"



Natural

FRAME GRIS
100x100 - 40"x40"
DUR1650

FRAME GRIS
60x60 - 24"x24"
DUR700

MOSAICO
FRAME GRIS
30x30 - 12"x12"
PESP500

Lappato

FRAME GRIS
100x100 - 40"x40"
DUR2200

FRAME GRIS
60x60 - 24"x24"
DUR1300

MOSAICO
FRAME GRIS
30x30 - 12"x12"
PESP500

Natural

FRAME GRAFITO
100x100 - 40"x40"
DUR1650

FRAME GRAFITO
60x60 - 24"x24"
DUR700

MOSAICO
FRAME GRAFITO
30x30 - 12"x12"
PESP500

Lappato

FRAME GRAFITO
100x100 - 40"x40"
DUR2200

FRAME GRAFITO
60x60 - 24"x24"
DUR1300

MOSAICO
FRAME GRAFITO
30x30 - 12"x12"
PESP500

Antislip

FRAME GRIS
100x100 - 40"x40"
DUR1900

FRAME GRIS
60x60 - 24"x24"
DUR900

NEW
PELD. RECTO EXTRUS.
FRAME GRIS
33x120
PESP6100

Antislipx2

FRAME GRIS
100x100x2 - 40"x40"x0,8"
DUR3900

Antislip

FRAME GRAFITO
100x100 - 40"x40"
DUR1900

FRAME GRAFITO
60x60 - 24"x24"
DUR900

NEW
PELD. RECTO EXTRUS.
FRAME GRAFITO
33x120
PESP6100

Antislipx2

FRAME GRAFITO
100x100x2 - 40"x40"x0,8"
DUR3900



Frame

Marfil



100x100 • 100x100x2 • 60x60
40"x40" • 40"x40"x0,8" • 24"x24"

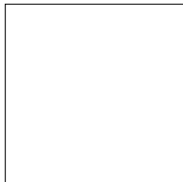

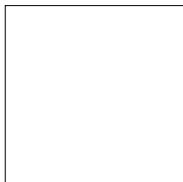

Natural

		
FRAME MARFIL 100x100 - 40"x40" DUR1650	FRAME MARFIL 60x60 - 24"x24" DUR700	MOSAICO FRAME MARFIL 30x30 - 12"x12" PESP500

Antislip

		
FRAME MARFIL 100x100 - 40"x40" DUR1900	FRAME MARFIL 60x60 - 24"x24" DUR900	NEW PELD. RECTO EXTRUS. FRAME MARFIL 33x120 PESP6100

Lappato

		
FRAME MARFIL 100x100 - 40"x40" DUR2200	FRAME MARFIL 60x60 - 24"x24" DUR1300	MOSAICO FRAME MARFIL 30x30 - 12"x12" PESP500

Antislipx2

FRAME MARFIL 100x100x2 - 40"x40"x0,8" DUR3900



FLOOR Frame Gris Lappato 60x60 - Frame Gris Antislip 60x60

Jasper

FLOOR Jasper White Antislip 60x120 - Peldaño Recto Jasper White Antislip 33x120

El entramado de líneas y vetas de su superficie, así como la riqueza de tonalidades propias de la piedra natural nos trasladan a lugares serenos y relajantes.

The network of lines and veins of its surface, as well as the richness of tonalities typical of natural stone take us to serene and relaxing places.



Resistencia - Endurance

Las piezas en espesor normal y las de espesor x2 permiten crear en cualquier zona de la terraza suelos antideslizantes, estables, resistentes y de bajo mantenimiento.

Both the pieces in normal thickness and those of x2 thickness allow to create non-slip, stable, resistant and low-maintenance floors in any area of the terrace.

Jasper

White

Grey

100x100 • 100x100x2 • 60x120

40"x40" • 40"x40"x0,8" • 24"x48"



MAX. 20%

C3 / R11

Natural

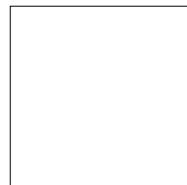

JASPER WHITE
100x100 - 40"x40"
DUR2200



JASPER WHITE
60x120 - 24"x48"
DUR1200



MOSAICO
JASPER WHITE
30x30 - 12"x12"
PESP500



MOSAICO LINEAL
JASPER WHITE
39x39 - 15,6"x15,6"
PESP1800

Natural



JASPER GREY
100x100 - 40"x40"
DUR2200



JASPER GREY
60x120 - 24"x48"
DUR1200



MOSAICO
JASPER GREY
30x30 - 12"x12"
PESP500



MOSAICO LINEAL
JASPER GREY
39x39 - 15,6"x15,6"
PESP1800

Antislip

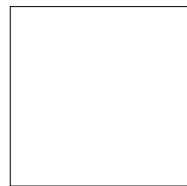

JASPER WHITE
100x100 - 40"x40"
DUR2200

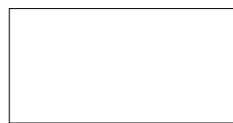

JASPER WHITE
60x120 - 24"x48"
DUR1200



NEW
PELD. RECTO EXTRUS.
JASPER WHITE
33x120
DUR6100

Antislipx2



JASPER WHITE
100x100x2 - 40"x40"x0,8"
DUR4100

Antislip



JASPER GREY
100x100 - 40"x40"
DUR2200

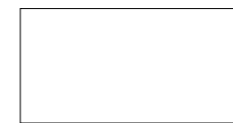

JASPER GREY
60x120 - 24"x48"
DUR1200



NEW
PELD. RECTO EXTRUS.
JASPER GREY
33x120
DUR6100

Antislipx2

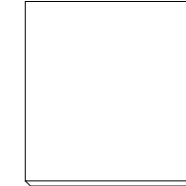

JASPER GREY
100x100x2 - 40"x40"x0,8"
DUR4100



Jasper

Nut

100x100 • 100x100x2 • 60x120
40"x40" • 40"x40"x0,8" • 24"x48"



Natural

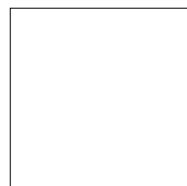

JASPER NUT
100x100 - 40"x40"
DUR2200



JASPER NUT
60x120 - 24"x48"
DUR1200



MOSAICO
JASPER NUT
30x30 - 12"x12"
PESP500



MOSAICO LINEAL
JASPER NUT
39x39 - 15,6"x15,6"
PESP1800

Antislip

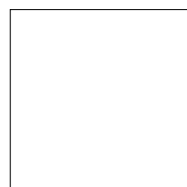

JASPER NUT
100x100 - 40"x40"
DUR2200



JASPER NUT
60x120 - 24"x48"
DUR1200



NEW
PELD. RECTO EXTRUS.
JASPER NUT
33x120
DUR6100

Antislipx2



JASPER NUT
100x100x2 - 40"x40"x0,8"
DUR4100



FLOOR Jasper Grey Antislip 60x120 - Peldaño Recto Jasper Grey Antislip 33x120

Tucson

FLOOR Tucson Grey Antislip 60x120 - Peldaño Recto Tucson Grey Antislip 33x120 - Tucson Bali 20x20



La combinación de una piedra suave y clara con otras de tonos ricos y vibrantes sorprende y nos descubre un resultado novedoso, exótico y muy atractivo.

The combination of a soft and clear stone with others of rich and vibrant tones surprises and reveals a novel, exotic and very attractive result.

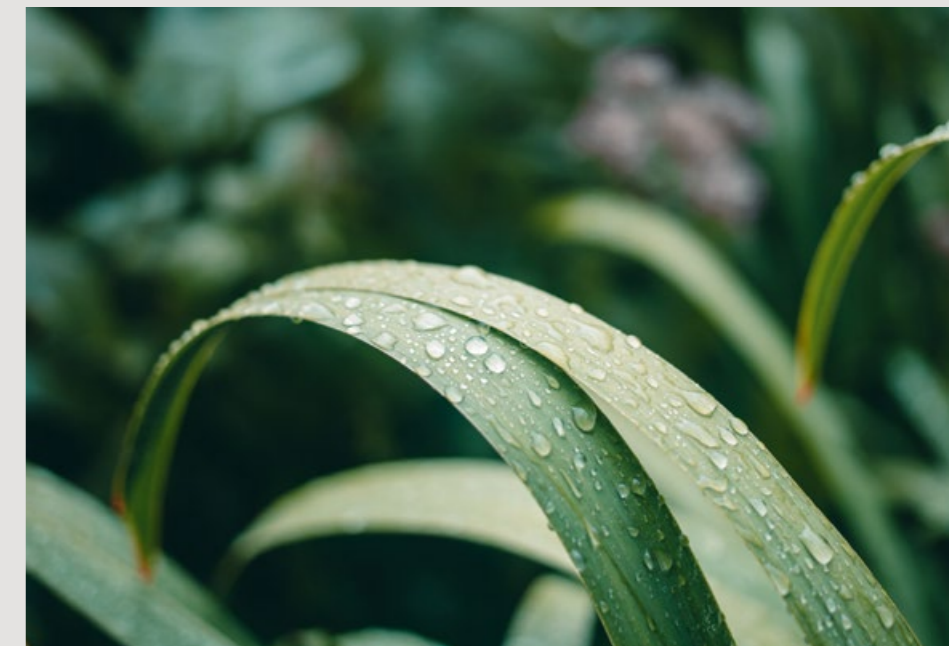



Tucson

Estética - Esthetics

La riqueza de diseños y texturas de las piezas cerámicas permite ampliar su uso a nuevas áreas como muebles aumentando el efecto decorativo de los mismos.

The richness of designs and textures of the ceramic pieces allows extending their use to new areas such as furniture, increasing their decorative effect.

Tucson



Polivalente - Polivalente

Muretes, jardineras o el fondo de la piscina pueden revestirse con porcelánico. Multiplica las posibilidades añadiendo tus propias ideas.

Walls, planters or the bottom of the pool can be covered with porcelain. Multiply the possibilities by adding your own ideas.

FLOOR

Tucson Grey Antislip 60x120
Peldaño Recto Tucson Grey Antislip 33x120
Tucson Java 20x20



Tucson

White

Grey

60x120 • 20x20

24"x48" • 8"x8"

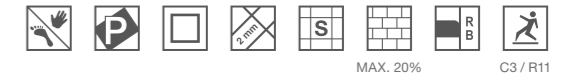

MAX. 20%

C3 / R11

Natural

C2



TUCSON WHITE
60x120 - 24"x48"
DUR1100



TUCSON BALI - PHUKET - JAVA
20x20 - 8"x8"
Q1150

Antislip



TUCSON WHITE
60x120 - 24"x48"
DUR1100



PELD. RECTO EXTRUS.
TUCSON WHITE
33x120
PESP6100

Natural

C2



TUCSON GREY
60x120 - 24"x48"
DUR1100



TUCSON BALI - PHUKET - JAVA
20x20 - 8"x8"
Q1150

Antislip



TUCSON GREY
60x120 - 24"x48"
DUR1100



PELD. RECTO EXTRUS.
TUCSON GREY
33x120
PESP6100

Tucson

Sand

60x120 • 20x20
24"x48" • 8"x8"



Natural

C2

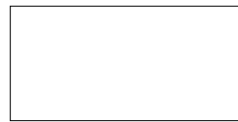

TUCSON SAND
60x120 - 24"x48"
DUR1100



TUCSON BALI - PHUKET - JAVA
20x20 - 8"x8"
Q1150

Antislip



TUCSON SAND
60x120 - 24"x48"
DUR1100



PELD. RECTO EXTRUS.
TUCSON SAND
33x120
PESP6100

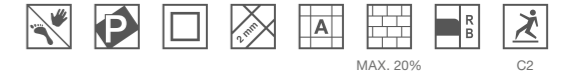

C2



TUCSON BALI 20x20 - 8"x8"
Q1150

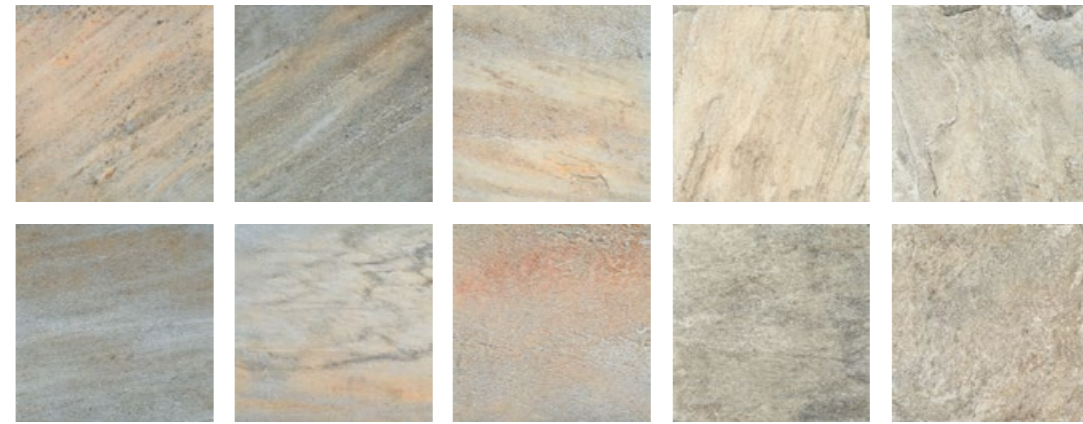

TUCSON PHUKET 20x20 - 8"x8"
Q1150



TUCSON JAVA 20x20 - 8"x8"
Q1150

Cada modelo tiene 30 diseños diferentes. Se sirven mezclados.
Each model has 30 different designs served mixed.

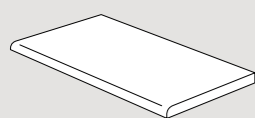

1. Peldaño canto romo

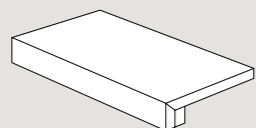

3. Peldaño torelo

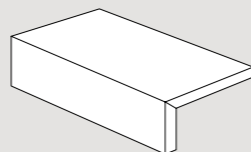

5. Peldaño tabica

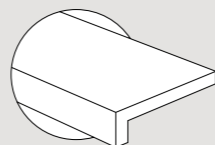

7. Peld. recto extrusionado

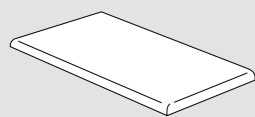

2. Peld. angular canto romo

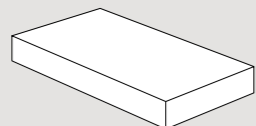

4. Peldaño angular torelo

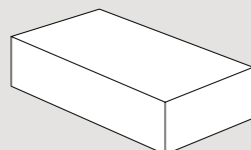

6. Peldaño angular tabica

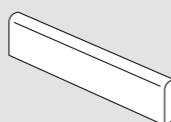

8. Rodapié



Peldaño extrusionado
Extruded straight stair

Pieza compacta, sin partes adheridas y de superficie antideslizante Clase 3/R11. Está concebida especialmente para rematar el coronamiento perimetral de la piscina. También resulta perfecta para escaleras exteriores.

Compact piece, without adhered parts and with a Class 3/R11 non-slip surface. It is specially designed to finish the perimeter crown of the pool. It is also perfect for exterior stairs.

Clunia	1. P. Canto romo	2. P. Ang. can. romo	3. P. Torelo	4. P. Angular torelo	5. P. Tabica	6. P. Ang. tabica	7. P. Recto extrusionado
100x100	PESP6100	PESP6600	PESP7400	PESP8500	PESP7200	PESP8700	33x120 PESP6100
100x100x2	PESP7000	PESP7500	PESP7500	PESP9500	PESP8700	PESP9000	8. Rodapié
75x75	PESP3100	PESP3700	PESP6800	PESP7400	PESP6600	PESP7400	8. Rodapié
60x120	PESP4500	PESP5000	PESP7200	PESP7500	PESP7100	PESP7500	9,5x100 PESP900
60x60	PESP1900	PESP2400	PESP6200	PESP7000	PESP6000	PESP7000	10x120 PESP1100
30x100	PESP2900	PESP3400	PESP6900	PESP7200	PESP6700	PESP6900	7,3x75 PESP300
30x100	PESP3100	PESP3300	PESP7100	PESP7400	PESP6900	PESP7000	7,3x60 PESP100
30x60	PESP1200	PESP1400	PESP5900	PESP6600	PESP5500	PESP6400	

Frame	1. P. Canto romo	2. P. Ang. can. romo	3. P. Torelo	4. P. Angular torelo	5. P. Tabica	6. P. Ang. tabica	7. P. Recto extrusionado
100x100	PESP6100	PESP6600	PESP7400	PESP8500	PESP7200	PESP8700	33x120 PESP6100
100x100x2	PESP7000	PESP7500	PESP7500	PESP9500	PESP8700	PESP9000	8. Rodapié
60x60	PESP1900	PESP2400	PESP6200	PESP7000	PESP6000	PESP7000	8. Rodapié
30x100	PESP2900	PESP3400	PESP6900	PESP7200	PESP6700	PESP6900	7,3x60 PESP100
30x60	PESP1200	PESP1400	PESP5900	PESP6600	PESP5500	PESP6400	9,5x100 PESP900

Jasper	1. P. Canto romo	2. P. Ang. can. romo	3. P. Torelo	4. P. Angular torelo	5. P. Tabica	6. P. Ang. tabica	7. P. Recto extrusionado
100x100	PESP6100	PESP6600	PESP7400	PESP8500	PESP7200	PESP8700	33x120 PESP6100
100x100x2	PESP7000	PESP7500	PESP7500	PESP9500	PESP8700	PESP9000	8. Rodapié
60x120	PESP4500	PESP5000	PESP7200	PESP7500	PESP7100	PESP7500	8. Rodapié
30x100	PESP2900	PESP3400	PESP6900	PESP7200	PESP6700	PESP6900	9,5x100 PESP900
30x100x2	PESP6000	PESP7100	PESP7000	PESP8500	PESP7000	PESP7100	10x120 PESP1100
30x120	PESP3100	PESP3300	PESP7100	PESP7400	PESP6900	PESP7000	

Tucson	1. P. Canto romo	2. P. Ang. can. romo	3. P. Torelo	4. P. Angular torelo	5. P. Tabica	6. P. Ang. tabica	7. P. Recto extrusionado
60x120	PESP4500	PESP5000	PESP7200	PESP7500	PESP7100	PESP7500	33x120 PESP6100
30x120	PESP3100	PESP3300	PESP7100	PESP7400	PESP6900	PESP7000	8. Rodapié
							10x120 PESP1100

Peldaños disponibles con hendiduras y sin hendiduras / Steps available striped and non striped

Lista de embalaje _ Packing list

Clunia	Piezas/Caja Pieces/Box	Kg/Caja Kg/Box	M2/Caja M2/Box	Caja/Palet Box/Pallet	M2/Palet M2/Pallet	Kg/Palet Kg/Pallet	Pieza Piece	Piezas/Caja Pieces/Box	Kg/Caja Kg/Box
100x100	2	52,40	2	24	48	1.257,60	MOSAICO 30x30	11	19,25
100x100x2	1	49,17	1	24	24	1.180,08	MOSAICO MURO 30x30	11	22
75x75	2	27,70	1,12	45	50,62	1.246,50			
60x120	2	32,30	1,44	30	43,20	969			
60x60	3	22,75	1,08	40	43,20	910			
30x60	6	23,52	1,08	40	43,20	940,80			

Frame	Piezas/Caja Pieces/Box	Kg/Caja Kg/Box	M2/Caja M2/Box	Caja/Palet Box/Pallet	M2/Palet M2/Pallet	Kg/Palet Kg/Pallet	Pieza Piece	Piezas/Caja Pieces/Box	Kg/Caja Kg/Box
100x100	2	47,70	2	24	48	1.144,80	MOSAICO 30x30	11	22
100x100x2	1	49,17	1	24	24	1.180,08			
60x60	4	30,18	1,44	32	46,08	965,76			

Jasper	Piezas/Caja Pieces/Box	Kg/Caja Kg/Box	M2/Caja M2/Box	Caja/Palet Box/Pallet	M2/Palet M2/Pallet	Kg/Palet Kg/Pallet	Pieza Piece	Piezas/Caja Pieces/Box	Kg/Caja Kg/Box
100x100	2	50,8	2	24	48	1.219,20	MOSAICO 30x30	11	19,25
100x100x2	1	47,5	1	24	24	1.140	MOSAICO LINEAL 39x39	11	24,50
60x120	2	36,10	1,44	30	43,20	1.083			

Tucson	Piezas/Caja Pieces/Box	Kg/Caja Kg/Box	M2/Caja M2/Box	Caja/Palet Box/Pallet	M2/Palet M2/Pallet	Kg/Palet Kg/Pallet
60x120	2	31,60	1,44	32	46,08	1.011,20
20x20	26	20,02	1,04	72	74,88	1.441,44

Características técnicas _ Technical features



2900 N / 11100N
ISO 10545/4



RESISTE
ISO 10545/12



UA
ISO 10545/13



INF. 0,5%
ISO 10545/3



5
ISO 10545/14



RECOMENDACIÓN DE USO
RECOMMENDED USE

DURSTONE

Este catálogo anula los anteriores. Los tonos y colores de las fotografías son una referencia a los modelos reales. CASA DEPOT SL (DURSTONE) no asume ninguna responsabilidad por errores de impresión en cualquier dato reflejado en el presente catálogo. Para la realización de cualquier pedido confirme los datos con CASA DEPOT SL (DURSTONE).

Todas las características y especificaciones técnicas están basadas en la información disponible en el momento de impresión del catálogo. CASA DEPOT SL (DURSTONE) se reserva el derecho de modificar, de acuerdo a las circunstancias de mercado y sin previo aviso, cualquier modelo, característica o prestaciones de sus productos sin que se contraiga derecho o perjuicio alguno.

This catalogue cancels the previous ones. Colors and tonalities of the pictures shown in this catalogue are a reference of the real models. CASA DEPOT SL (DURSTONE) does not take any responsibility of printing mistakes in any data of this catalogue. Check and confirm the data with CASA DEPOT SL (DURSTONE) before any order.

All technical characteristics and specifications are based on the available information at the printing moment. CASA DEPOT SL (DURSTONE) reserves the right to modify, according to changes in markets, and without any prior advice any model, characteristics or other information of its products without any responsibility or any commitment.

VENTAS Y LOGÍSTICA

SALES & LOGISTICS

CV 20, AV / Mediterraneo, 52
(Apdo. Correos 419)
12200 - Onda (Castellón)
durstone@durstone.es
TLF: 964 62 61 34
FAX: 964 62 61 35

ADMINISTRACIÓN

ADMINISTRATION

CASA DEPOT S.L.
CIF: B-97471098
Plaza Ayuntamiento, 19 - 9º G
46002 (Valencia)
TLF: 96 351 11 49



www.durstone.es

